

Overview

The BAPI-Stat “Quantum” Style room unit is available as a humidity only sensor or as a combination temperature and humidity sensor with optional LCD display, temperature setpoint adjustment and occupant override. It is available with the entire line of BAPI temperature sensors.

Fig 1: BAPI-Stat “Quantum” Room Humidity Sensor with Included Screw Pack

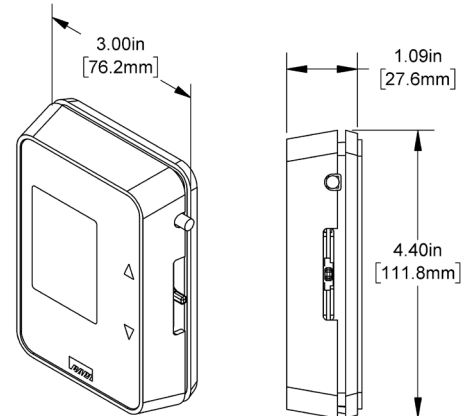

Mounting

Mounting hardware is provided for both junction box and drywall installation (junction box installation shown).

JUNCTION BOX

1. Pull the wire through the wall and out of the junction box, leaving about six inches free.
2. Pull the wire through the hole in the base plate.
3. Secure the plate to the box using the #6-32 x 1/2 inch mounting screws provided.
4. Terminate the unit according to the guidelines in the **Termination** section.
5. Attach cover by latching it to the top of the base, rotating down and snapping into place.
6. Secure the cover by backing out the lock-down screws using a 1/16” Allen wrench until they are flush with the bottom of the cover.

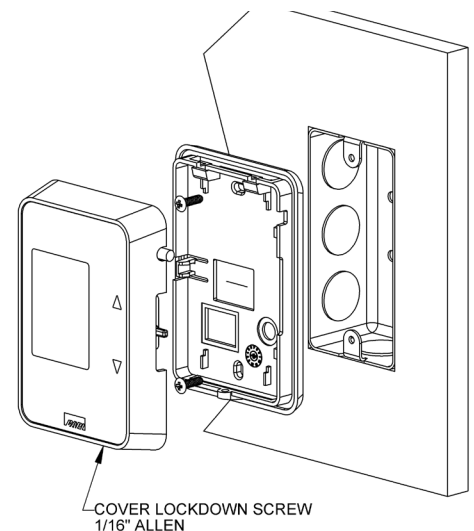

Fig 2: Mounting to a Junction Box

DRYWALL MOUNTING

1. Place the base plate against the wall where you want to mount the sensor.
2. Using a pencil mark out the two mounting holes and the area where the wires will come through the wall.
3. Drill two 3/16” holes in the center of each marked mounting hole. Insert a drywall anchor into each hole.
4. Drill one 1/2” hole in the middle of the marked wiring area.
5. Pull the wire through the wall and out of the 1/2” hole, leaving about six inches free.
6. Pull the wire through the hole in the base plate.
7. Secure the base to the drywall anchors using the #6 x 1 inch mounting screws provided.
8. Terminate the unit according to the guidelines in the **Termination** section.
9. Attach cover by latching it to the top of the base, rotating the cover down and snapping it into place. Secure the cover by backing out the lock-down screws using a 1/16” Allen wrench until they are flush with the bottom of the cover.

NOTE: In any wall-mount application, the wall temperature and the temperature of the air within the wall cavity can cause erroneous readings. The mixing of room air and air from within the wall cavity can lead to condensation, erroneous readings and premature failure of the sensor. To prevent these conditions, seal the conduit leading to the junction box or fill the box with insulation.

Terminations

BAPI recommends using twisted pair of at least 22 AWG. Larger gauge wire may be required for long runs. All wiring must comply with the National Electric Code (NEC) and local codes. Do NOT run this device’s wiring in the same conduit as AC power wiring of NEC class 1, NEC class 2, NEC class 3 or with wiring used to supply highly inductive loads such as motors, contactors and relays. BAPI’s tests show that fluctuating and inaccurate signal levels are possible when AC power wiring is present in the same conduit as the signal lines.

BAPI recommends wiring the product with power disconnected. Proper supply voltage, polarity, and wiring connections are important to a successful installation. Not observing these recommendations may damage the product and will void the warranty.

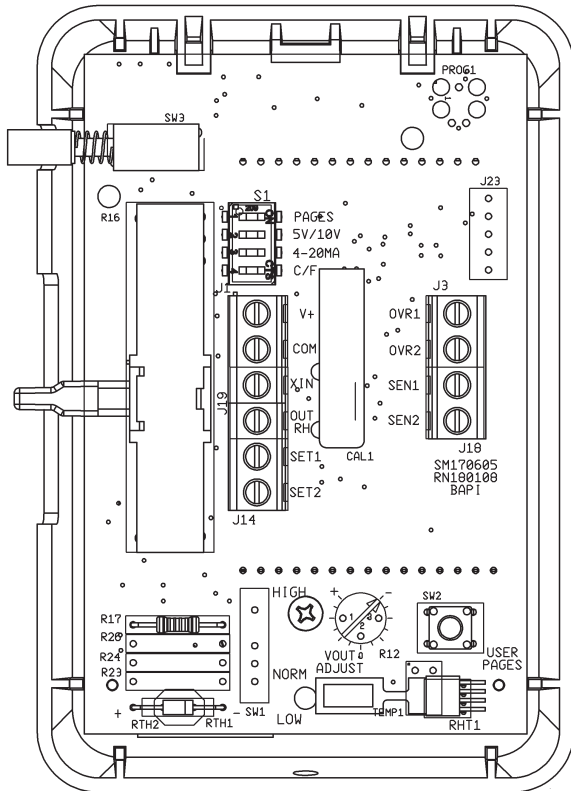

Fig 3: Circuit Board

0 to 5 VDC and 0 to 10 VDC Output Unit Termination

<u>Terminal</u>	<u>Function</u>
V+	Power, see specifications section for details.
COM	To controller power supply ground.
XIN.....	Allows remote control of the LCD indicator for occupancy, and is activated by logic LOW or power supply ground at this terminal.
OUT RH.....	Voltage Humidity Signal [to analog input of controller].
SET1 & SET2	Temperature Setpoint Output. If unit is a Common Ground model, see Note below.
OVR1 & OVR2...	Override Output – Dry Contact Switch. If unit is a Common Ground model, see Note below.
SEN1 & SEN2 ...	Temperature Sensor Output – Resistance. If unit is a Common Ground model, see Note below.

4 to 20 mA Output Unit Termination

<u>Terminal</u>	<u>Function</u>
V+	Power, see specifications section for details.
COM	4 to 20 mA Humidity Signal [to analog input of controller].
XIN.....	Allows remote control of the LCD indicator for occupancy, and is activated by logic LOW or power supply ground at this terminal.
OUT RH.....	Not Used.
SET1 & SET2	Temperature Setpoint Output. If unit is a Common Ground model, see Note below.
OVR1 & OVR2...	Override Output – Dry Contact Switch. If unit is a Common Ground model, see Note below.
SEN1 & SEN2 ...	Temperature Sensor Output – Resistance. If unit is a Common Ground model, see Note below.

Notes:

On Common Ground (default) Models:

Resistive Setpoint: Terminals “OVR2”, “SEN2”, and “SET2” are connected together internally but they are not connected to Ground “COM”. If you intend to use “COM” as common, then a jumper must be added from terminal “COM” to “SEN2”. This is only allowed on Humidity Voltage Output Models. Do not install this jumper on Humidity 4 to 20 mA Output models.

Voltage Setpoint: Terminals “OVR2”, “SEN2”, and “SET2” are connected to Ground “COM”. This is only allowed on Humidity Voltage Output models. Do not adjust DIP Switch S1 to Humidity 4 to 20mA Output as the output will be shared with OVR2, SEN2, and SET2.

On Differential Ground Models:

All terminals are independent unless unit is configured for Voltage Setpoint (in that case SET2 is connected to COM).

Specifications subject to change without notice.

Optional Test Balance Switch (SW2)

The test and balance switch is used by the balancer to equalize the flow of air or water. It can also be used to verify sensor termination in a point-to-point checkout of the control system. The "NORM" position allows the real sensor to be monitored. The "HI" position forces the output to a very hot reading and the "LOW" position forces the output to a very cold output (See Table 1).

Optional Test and Balance Switch (SW2)

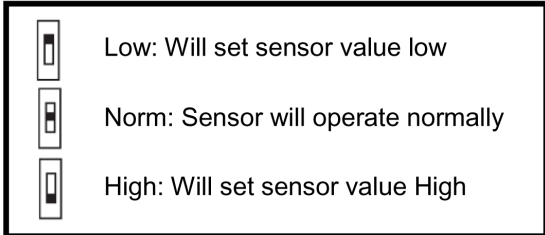
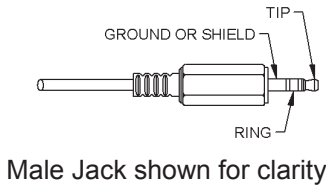

Table 1: Test and Balance Resistance Values

Sensor Type	Low Temp	High Temp
1000 Ω RTD	1.02K Ω (41.2°F)	1.15K Ω (101.5°F)
3000 Ω Thermistor	7.87K Ω (39.8°F)	1.50K Ω (106.8°F)
10K-2 Thermistor	30.1K Ω (34.9°F)	4.75K Ω (109.1°F)
10K-3 Thermistor	26.7K Ω (35.9°F)	5.11K Ω (108.4°F)
10K-3(11K) Thermistor	7.32K Ω (43.7°F)	3.65K Ω (105.2°F)

Optional Communications Jack Wiring



C35L Wiring	
	Wire Color
Ground	Black
Tip	White
Ring	Red

Fig 4: C35L Communications Jack

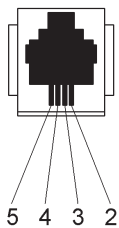

C11L/C22L Wiring	
Comm Jack Pin	Wire Color
1	Not Connected
2	Black
3	Red
4	Yellow
5	Green
6	Not Connected

Fig 5: C11L/C22L Communications Jack

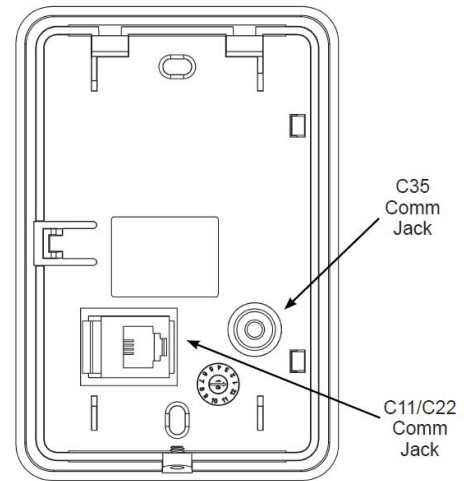

Fig 6: Communications Jack Locations

Humidity Output and °C or °F Display DIP Switch (S1)

S1

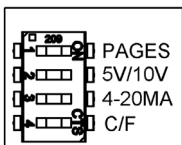

Fig 7:

Humidity Output
DIP Switches

NOTE: When looking at DIP Switch S1, ON is to the right, OFF is to the left.

PAGES: Factory set to the OFF position. To enter into Program Mode, switch to ON.

5V/10V: Sets the humidity output. Factory set per the configuration ordered. For 0 to 5V output, switch is OFF. For 0 to 10V output, switch is ON.

4-20MA: Sets the humidity output. Factory set per the configuration ordered. For 4 to 20mA output, Switch is ON. For 0 to 5V and 0 to 10V outputs, Switch is OFF. Do not set to 4 to 20mA output if temperature setpoint is a voltage output.

C/F: Sets the temperature display in °C (Celsius) or °F (Fahrenheit). Factory set per the configuration ordered. For °C, switch is OFF. For °F, switch is ON. When unit does not have a display, switch is shipped in ON position.

Specifications subject to change without notice.

Humidity Offset Potentiometer (R12) for units without display

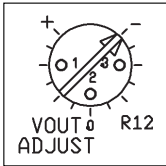

Potentiometer R12 can be used to adjust the humidity output by $\pm 5\%$ for units without display. A high accuracy humidity reference is recommended. Note: For units with display, the offset is set via the programming pages described in the Optional Technician Adjustments section on page 5.

Fig 8: R12 %RH Adjustment Potentiometer

User Operation

The display indicates temperature in degrees Fahrenheit or Celsius, relative humidity in %RH, temperature setpoint in degrees Fahrenheit or Celsius. Temperatures and relative humidity can be displayed in a rotating manner, see the Optional Technician Adjustments section. The BAPI Man icon indicates that the override button has been pushed.

Temperature:

Displayed in Fahrenheit or Celsius. Can rotate between major and minor of display with relative humidity.

Relative Humidity:

Displayed in %RH. Can rotate between major and minor of display with temperature.

Temperature Setpoint Slidepot:

Moving the slidepot enough to change the setpoint will display the setpoint in the major of the display if equipped with display. The setpoint temperature display will flash the digits indicating that setpoint is being changed.

Override Button:

When the override button is pressed on display units, the BAPI Man Icon will display. A dry resistance of less than 15 ohms appears across the override output. Latching the Icon to show that the system is in override requires that a dry contact on your controller be used to connect terminal XIN to ground.

Note: The unit must receive a confirmation (ground) signal on the “XIN” terminal for the BAPI-Man to remain visible on the screen. Pressing the Override button will light the BAPI Man icon; however, if no confirmation signal is received, then the BAPI Man will go blank (disappear) after 5 seconds.

Upon receiving a first confirmation (ground) signal on the “XIN” terminal, the BAPI Man will show occupied (Solid). The BAPI Man will then show unoccupied (Hollow) whenever the confirmation signal is removed and occupied when the signal is returned. The only way to blank the BAPI Man from the display at this point is to cycle power

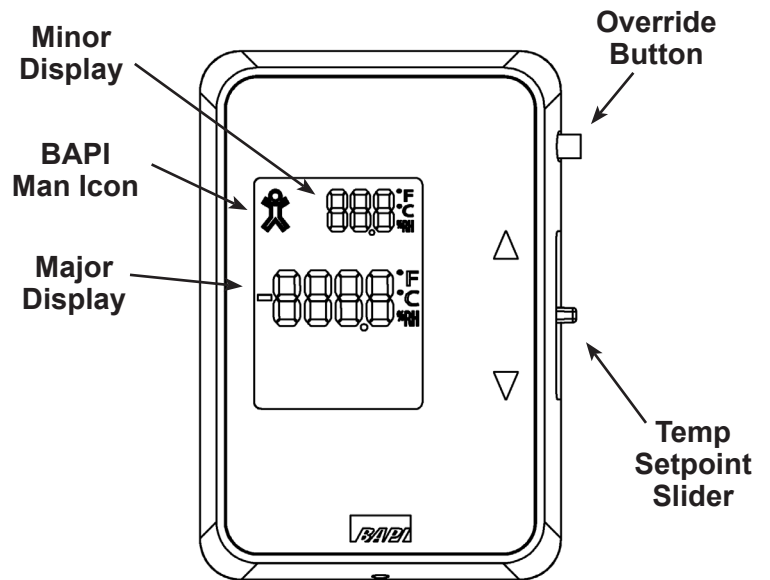

Fig 9: BAPI-Stat “Quantum” Humidity Unit Indicators (Shown with all optional indicators)

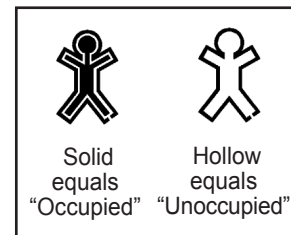

Fig. 10: BAPI Man Icon

Optional Technician Adjustments

Adjustments for Units with a Display

The optional technician adjustments allows a technician to set temperature and humidity offsets, display settings and output parameters. There are nine pages with programmable parameters.

Entering Program Mode to Adjust Parameters (see Figs. 11-13 for adjustment tools)

1. Power unit and set DIP Switch S1 #1 (PAGES) to ON (right). The LCD will show a page number (P1-P9) based on the location of the Slide Potentiometer R16. P1-P9 will flash to indicate that display parameter can be adjusted.
2. Slide Potentiometer R16 is used to scroll up and down through pages and adjusting the page parameters.
NOTE: For units with Temperature Setpoint, the Slide Potentiometer will extend outside the enclosure. For units without Temperature Setpoint, the Slide Potentiometer will not be extended outside the enclosure.
3. Push Switch SW2 as “Enter” to switch between pages and adjusting the page parameter.
4. After a page parameter has been adjusted, push Switch SW2 to confirm the change.
5. To exit Program Mode, Set DIP Switch #1 (PAGES) to OFF (left).

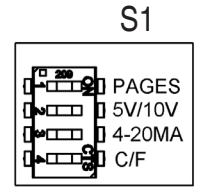

Fig 11: DIP Switch S1

Programming Pages		
Parameter	Page	Adjustment
Temperature Offset	P1	±5° in 0.1° increments
Humidity Offset	P2	±5%RH in 0.1%RH increments
Temperature Display	P3	Item Display Action
		0 Display in whole digits
		1 Display in 0.5° increments, °F and °C
Humidity Display	P4	Item Display Action
		0 Display in whole digits
		1 Display in 0.5%RH increments
Temperature Setpoint Display Low	P5	Adjust the Low Temperature of the setpoint range
Temperature Setpoint Display High	P6	Adjust the High Temperature of the setpoint range
Humidity Output Low	P7	Adjust the Low Humidity output
Humidity Output High	P8	Adjust the High Humidity output
Display Options	P9	Item Display Action
		0 Temperature and Humidity rotate between major and minor, Setpoint when active
		1 Temperature and Humidity rotate between major and minor
		2 Temperature in major, Humidity in minor
		3 Humidity in major, Temperature in minor
		4 Temperature in Major, minor is off
5 Humidity in Major, minor is off		

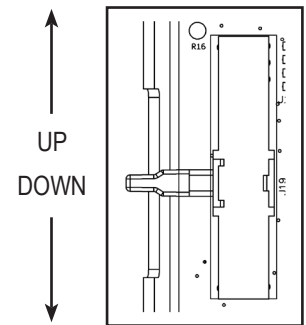

Fig 12: R16 Slide Potentiometer (for making program adjustments)

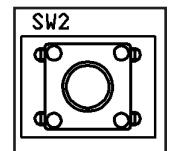

Fig 13: SW2 Calibration Switch

Specifications

Power:

12 to 35 VDC for 4 to 20 mA or 0 to 5 VDC Output
 15 to 35 VDC for 0 to 10 VDC Output
 15 to 28 VAC for 0 to 5 VDC or 0 to 10 VDC Output
 (AC Power requires a separate pair of shielded wires)

Power Consumption:

20 mA max. for 4 to 20 mA Output
 4 mA max. for 0 to 5 VDC and 0 to 10 VDC Output
 0.1 VA max. for 0 to 5 VDC and 0 to 10 VDC Output

Wiring:

2 to 5 pair of 16 to 22 AWG

Terminals:

Cage clamp, 16 to 22 AWG

Material & Rating:

ABS Plastic, UL 94, V-0

Sensing Elements:

Temperature - Thermistor or RTD
 Humidity - Capacitive Polymer
 ±2%RH @ 25°C (77°F), 20 to 80%RH

Field Calibration:

Potentiometer (R12), ±5% in 0.1% increments (Units are factory calibrated)

Mounting:

2"x4" J-box or drywall - screws provided

Environmental Operation Range:

Temperature: 32 to 122 °F (0 to 50 °C)
 Humidity: 0 to 95%, non-condensing

Agency:

RoHS

Specifications subject to change without notice.



BAPI-Stat "Quantum" Room Humidity Sensor

Installation & Operating Instructions

41147_ins_quantum_hum

rev. 07/12/18

Diagnostics

Possible Problems:

General troubleshooting

Possible Solutions:

- Determine that the input is set up correctly in the controller and BAS.
- Check wiring at the sensor and controller for proper connections.
- Label the wire terminals at the sensor end and the controller end. Disconnect the interconnecting wires from the controller and the sensor. With the interconnecting wires separated at both ends measure the resistance from wire-to-wire with a multimeter. The meter should read greater than 10 Meg-ohms, open or OL depending on the meter you have. Short the interconnecting wires together at one end. Go to the other end and measure the resistance from wire-to-wire with a multimeter. The meter should read less than 10 ohms (22 gauge or larger, 250 feet or less). If either test fails, replace the wire.
- Determine if the sensor is exposed to an external source different from the room environment (conduit draft). Plug the conduit or fill the handy box as necessary. DO NOT use silicon caulk.

Incorrect Humidity

- Check power supply/controller voltage supply
- Disconnect sensor and check power wires for proper voltage (see specifications page)
- Check all software parameters
- Check the sensor humidity output against a reference. Measure the humidity at the sensor's location using an accurate standard. Disconnect the humidity channel wires and measure the humidity signal with a multi-meter and compare to the reference, using the equations at right for the reference. If the output and reference differ by more than 5%, call BAPI technical support.

4-20mA Humidity Equation

$$RH = RH_{Low} + \frac{(A - 4) \times (RH_{Span})}{16}$$

RH = %RH at sensor
 RH_{Low} = Low %RH of Span
 RH_{High} = High %RH of Span
 RH_{Span} = RH_{High} - RH_{Low}
 A = Signal reading in mA

Voltage Humidity Equation

$$RH = RH_{Low} + \frac{(V - V_{Low}) \times (RH_{Span})}{V_{Span}}$$

RH = %RH at sensor
 RH_{Low} = Low %RH of Span
 RH_{High} = High %RH of Span
 RH_{Span} = RH_{High} - RH_{Low}
 V_{Low} = Low transmitter voltage usually=(0v)
 V_{High} = High transmitter voltage usually=(5 or 10v)
 V_{Span} = V_{High} - V_{Low}
 V = Signal reading in volts

Incorrect Temperature

- Determine that the temperature sensor's wires are connected to the correct controller input terminals, and check the wires at the sensor and controller for proper connections.
- Measure the physical temperature at the sensor's location using an accurate temperature standard. Disconnect the temperature sensor's wires (Terminals SEN1 & SEN2) and measure the temperature sensor's resistance across the output pins. Put the ohmmeter black lead on SEN2 and the red lead on SEN1. Compare the temperature sensor's resistance to the appropriate Sensor Resistance Table on the BAPI website (See below). If the measured resistance varies from the table by more than 5%, call BAPI technical support.

How to Find The Temperature Sensor Resistance Table

Find BAPI's web site at www.bapivac.com; click on "Resource Library" and "Sensor Specs" and then click on the sensor type you have.

Specifications subject to change without notice.