

Product Identification

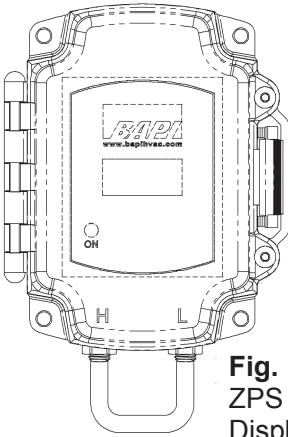

Fig. 1:
ZPS with Display

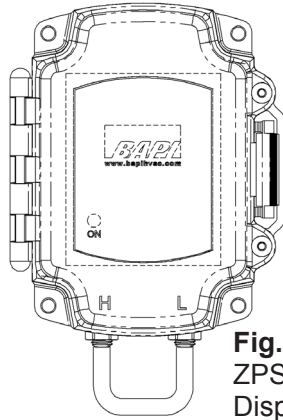

Fig. 2:
ZPS without Display

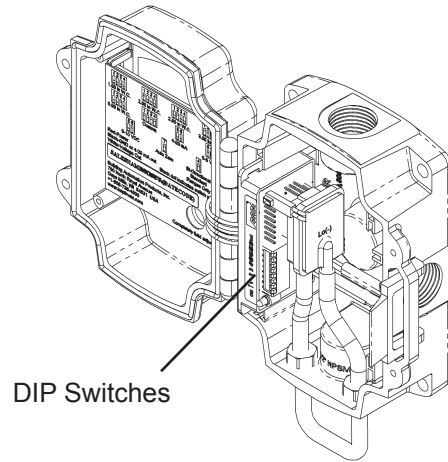

Fig. 3:
ZPS Display Unit Open

Specifications

Power:

7 to 40 VDC (4 to 20 mA Output)
7 to 40 VDC or 18 to 28 VAC (0 to 5 VDC Output)
13 to 40 VDC or 18 to 28 VAC (0 to 10 VDC Output)

Power Consumption:

20 mA max, DC only at 4 to 20 mA Output
4.9 mA max DC at 0 to 5 VDC or 0 to 10 VDC Output
0.12 VA max AC at 0 to 5 VDC or 0 to 10 VDC Output

Load Resistance:

4 to 20 mA Output 850 Ω Maximum @ 24 VDC
0 to 5 VDC or 0 to 10 VDC output 1KΩ minimum

Accuracy at 72°F:

±0.5% of range 0 to 0.1", 0 to 0.25", ±0.1" and ±0.25" ranges
±0.5% of range 0 to 30 Pa, 0 to 50 Pa, ±30 Pa and ±50 Pa ranges
±0.25% of range all other ranges

Stability: ±0.25% F.S. per year

Temperature Error:

0.04% FS/°F (0.07% FS/°C) (±1.0" W.C. @ 14 to 140°F [-10 to 60°C])

Environmental Operation Range: 14 to 140°F (-10 to 60°C)

Storage Temperature: -40 to 203°F (-40 to 95°C)

Overpressure: Proof: 27.68 in W.C (1 PSI),
Burst: 41.52 in W.C. (1.5 PSI)

Wiring: 2 wires (4 to 20mA Current loop)*
3 wires (AC or DC powered, Voltage out)*

Humidity: 0 to 95% RH, non-condensing

Port Connection:

1 High Pressure & 1 Low Pressure for push-on
1/4-inch tubing (1/8" to 3/16" I.D.)

Enclosure Material:

UV-resistant Polycarbonate, UL94, V-0

Enclosure Rating: IP66, NEMA 4

Mounting: Four external tabs with holes for #10 screws

Table 1: Pressure Ranges

Inches Unit				Pascal Unit			
Range	Pressure	Range	Pressure	Range	Pressure	Range	Pressure
51	0 to 0.10 in W.C.	56	± 0.10 in W.C.	61	0 to 30 Pa	66	± 30 Pa
52	0 to 0.25 in W.C.	57	± 0.25 in W.C.	62	0 to 50 Pa	67	± 50 Pa
53	0 to 0.50 in W.C.	58	± 0.50 in W.C.	63	0 to 100 Pa	68	± 100 Pa
54	0 to 0.75 in W.C.	59	± 0.75 in W.C.	64	0 to 175 Pa	69	± 175 Pa
55	0 to 1.00 in W.C.	60	± 1.00 in W.C.	65	0 to 250 Pa	70	± 250 Pa

Mounting

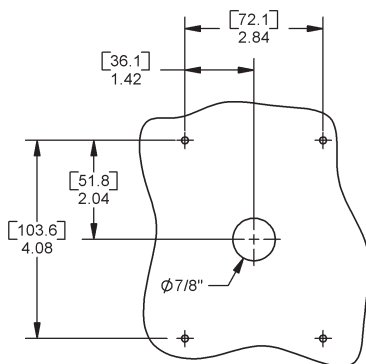

Figure 4: Mounting Hole Pattern

Note: BAPI recommends using #10 screws that require 5/32" pilot holes.

Attach the unit to its mounting surface with four #10 screws through the holes in the mounting feet. The preferred mounting orientation is with the pressure ports facing down.

Note: Remove Blue Dust Shields from pressure ports before use. Push tubing onto the port nipple. Avoid kinks and holes in the tubing or accuracy will be affected.

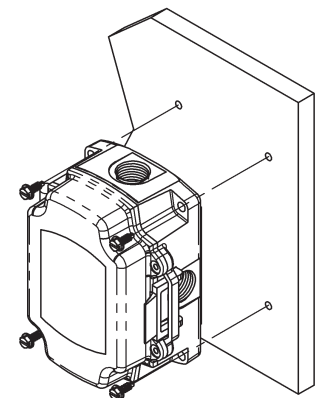

Figure 5:
Mounting Screws Location

Specifications subject to change without notice.

Output Termination



BAPI recommends wiring the product with power disconnected. Proper supply voltage, polarity and wiring connections are important to a successful installation. Not observing these recommendations may damage the product and void the warranty.

Output Signal	Red Wire (V+)	Black Wire (Gnd or 4-20mA Return)	White Wire (Voltage Output)
4 to 20 mA	7 to 40 VDC	4 to 20 mA Signal To Controller Analog Input	Not Used
0 to 5 VDC	7 to 40 VDC or 18 to 28 VAC	To Controller Ground	0 to 5 VDC Signal To Controller Analog Input
0 to 10 VDC	13 to 40 VDC or 18 to 28 VAC	To Controller Ground	0 to 10 VDC Signal To Controller Analog Input

Current Loop Wiring: 4 to 20 mA is “two wire” operation. The ZPS’s red wire connects to a positive direct current voltage of 7 to 40 VDC. The black wire becomes the return of the 4 to 20 mA signal. The white wire is not used but must be insulated from accidental contact with ground or any other potential. For 4 to 20 mA signaling, only direct current can be used to power the ZPS.

Voltage Output Wiring: 0 to 5 V or 0 to 10 V is “three wire” operation. The ZPS’s red wire connects to either 7 to 40 VDC or 18 to 28 VAC for 0 to 5 VDC output or 13 to 40 VDC or 18 to 28 VAC for 0 to 10 VDC output. The black wire is connected to ground and the white wire is connected to an analog input of the controller. BAPI insulates the white wire in the factory before shipping, so remove the connector and strip the insulation from the white wire as desired.

To ensure that all wires are properly terminated, twist the stripped ends of each circuit together before inserting into the splice terminals. Gently tug on the wire after terminating to make sure of a good connection. If the wire comes out of the termination, repeat the splice procedure.

Dip Switch Settings - Inches, Pascals, Display and No Display

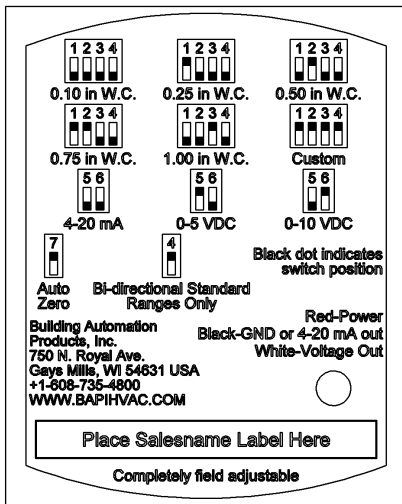

Figure 6:
DIP Switch Settings,
ZPS with No Display,
Inches W.C.

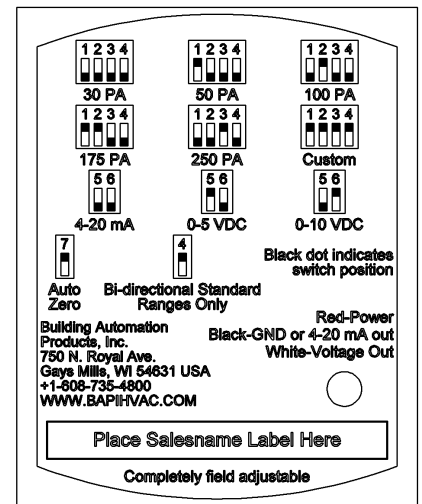

Figure 7:
DIP Switch Settings,
ZPS with No Display,
Pascals

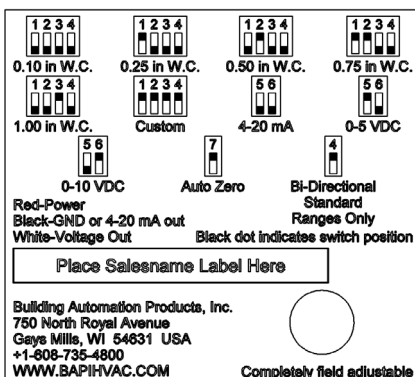

Figure 8:
DIP Switch Settings,
ZPS with Display,
Inches W.C.

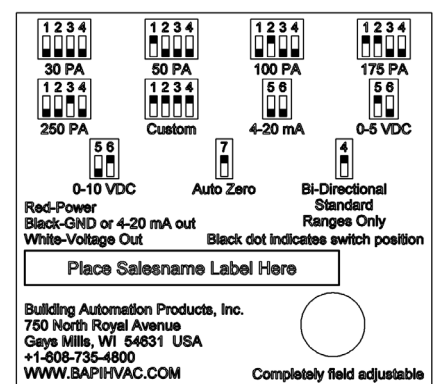

Figure 9:
DIP Switch Settings,
ZPS with Display,
Pascals

Specifications subject to change without notice.

Pressure Range Select

To adjust the pressure range, set dip switches 1-4 to the desired pressure range using the the label found inside the cover of the ZPS unit (See Figures 6-9). Moving the Bi-Directional dip switch (#4) to the up position doubles the pressure range. For example, the 0 to 2.5" W.C. range becomes -2.5" to 2.5" W.C. if the Bi-Directional dip switch is in the up position.

Note: If any of the switches are placed in an undefined combination the LED will blink at a fast rate and the output will be forced to 4mA or zero volts.

Output Range Select

To adjust the output range, set dip switches 5 & 6 to the desired output range using the the label found inside the cover of the ZPS unit (or shown on pg 2).

Note: If any of the switches are placed in an undefined combination the LED will blink at a fast rage and the output will be forced to 4mA or zero volts.

Auto-Zero Select

To auto-zero the BAPI ZPS, remove the tubing from the pressure ports (to remove the normal pressure source). Make sure that the pressure ports are sheltered from any drafts, including the technician's breath. Ideally the two ports should be connected together with a short piece of tubing.

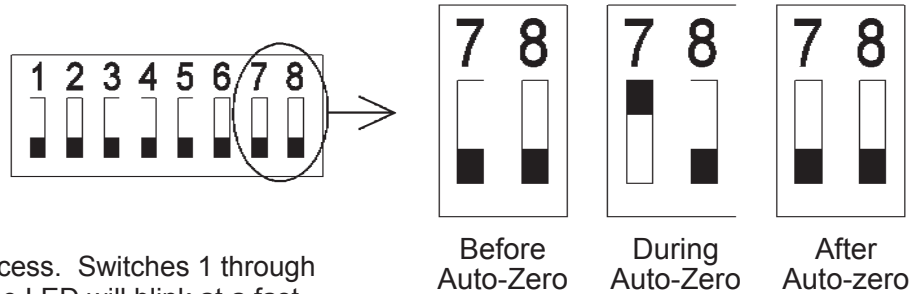

Fig. 10: Auto-Zero Switch 7

Turn on switch 7 to start the auto-zero process. Switches 1 through 6 may be in any allowed configuration. The LED will blink at a fast rate and the output will be forced to zero (4mA or 0V) while the auto-zero is being performed. When the LED blinks at a slow rate, turn off switch 7 and reconnect the pressure source.

Note: Switch 8 is reserved for Factory use, leave in the off position.

Typical Applications

Fig. 11: Duct static pressure monitoring, BAPI ZPS Pressure Transmitter mounted in a panel with ZPS-ACC07 in duct.

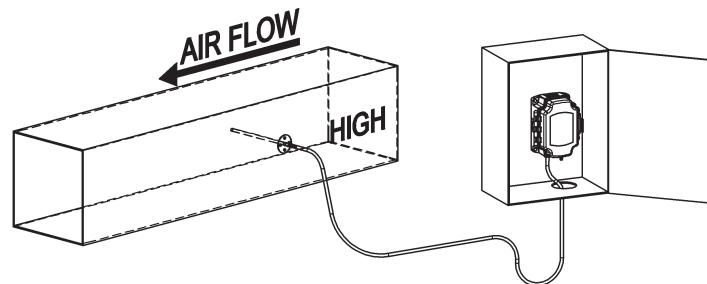

NOTE: Best practice is to form a drip loop in the tubing to prevent condensation from reaching the ZPS.

Fig. 12: Air filter pressure drop monitoring, ZPS Pressure Transmitter mounted in a panel with two ZPS-ACC07 in duct.

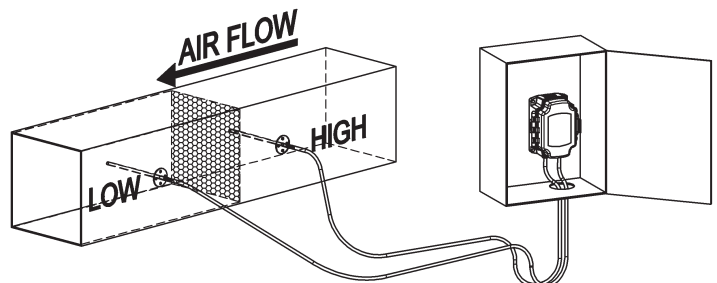

Specifications subject to change without notice.

Typical Applications continued...

Fig. 13:

Duct static pressure monitoring, BAPI ZPS Pressure Transmitter mounted on the duct with ZPS-ACC07 in duct.

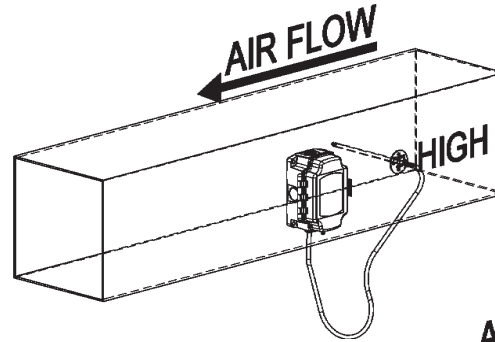

NOTE: Best practice is to form a drip loop in the tubing to prevent condensation from reaching the ZPS.

Fig. 14:

Air filter pressure drop monitoring, BAPI ZPS Pressure Transmitter mounted on the duct with two ZPS-ACC07 in duct.

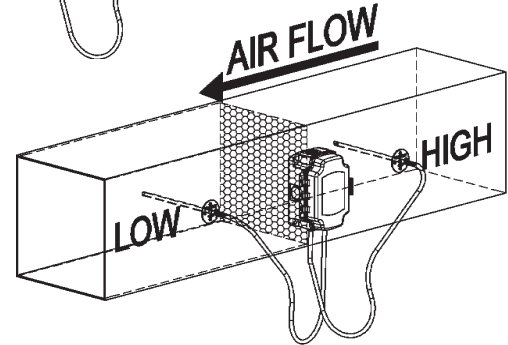

Troubleshooting

PROBLEMS:

LED does not light

LED is blinking fast
(1/2 second on, 1/2 second off)

Output stuck (high or low)

Output not tracking pressure properly

POSSIBLE SOLUTIONS:

- Check power connections for proper power

- The unit may be performing an auto-zero. Wait 10 seconds and check again.

- The dip switches are in an unsupported configuration, check the dip switch settings, both pressure and output, and change them to ranges desired

- Remove pressure from ports and perform auto-zero procedure

- Check dip switches for proper pressure range selection

- Check dip switches for proper output range selection

LED Operation

LED off	No Power
LED Blinking 1/2 sec on, 1/2 sec off	Auto-zero or dip switch in undefined configuration
LED on	Normal operation
LED Blinking 1/2 sec on, 4 sec off	Auto-zero complete

Specifications subject to change without notice.