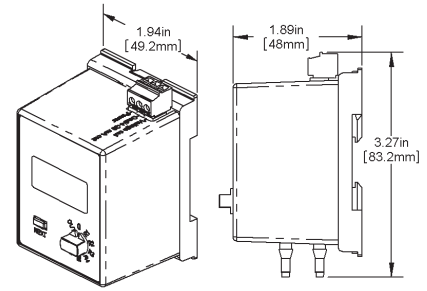

Identification and Overview

BAPI's EZ Low Pressure Sensor is a true differential pressure transmitter that provides ± 1 inches WC (± 250 Pacals) in 10 field selectable ranges (see specifications). BAPI's EZ enclosure is designed for DIN rail, Snaptrack or surface mounting. Three output ranges of 0 to 5 VDC, 0 to 10 VDC and 4 to 20 mA are also field selectable for all pressure ranges. The wiring terminal block is depluggable. Pressure units of inches of Water Column or Pascals are available at the time of order.

**Fig. 1:** EZ Low Pressure Sensor**Mounting**

The EZ Mount Base has mounting tabs that can be extended or pushed in for the three mounting methods.

DIN Rail Mounting, Figs 2-3.

- Pull out the blue mounting tabs.
- Catch the EZ mount hook on DIN rail as shown in Fig 3.
- Rotate the EZ pressure module down until the bottom mounting tab snaps into place on the DIN rail.
- Connect wires and pressure lines as needed.

Snaptrack Mounting, Fig 4.

- Push in the blue mounting tabs.
- Snap the EZ Mount base into the board slots in the 2.75 inch snaptrack.
- Connect wires and pressure lines as needed.

Surface Mounting, Fig 5

- Pull out the blue mounting tabs.
- Place the EZ Pressure unit against the surface and mark the screw holes.
- Drill 1/8" pilot holes for #8 flathead screws.
- Screw unit to the surface. The holes in the blue mounting tabs are elongated to allow for alignment.
- Connect wires and pressure lines as needed.

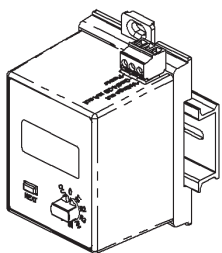
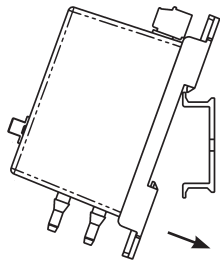
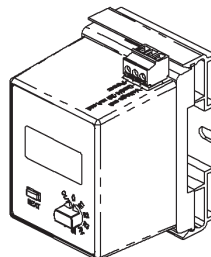
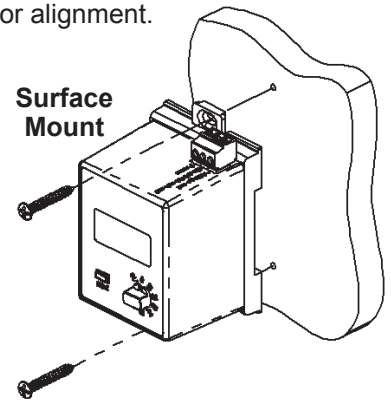
DIN Rail Mount**Fig. 2:** DIN Rail Mounting with tabs out.**Fig. 3:** Catch the EZ Mount hook on the edge of the DIN Rail, then rotate into place.**Snaptrack Mount****Fig. 4:** Snaptrack Mounting with tabs in.**Surface Mount****Fig. 5:** Surface Mounting with the tabs out.**Pressure Connections**

The Pressure ports will accept 1/4" tubing (1/8" or 3/16" ID).

- Connect the high pressure to the port labeled High
- Connect the low pressure to the port labeled Low

The output will be the pressure difference between the high and low port.

Note: Remove blue dust covers from pressure ports before use.

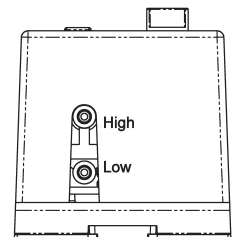
**Fig. 6:** Pressure Port Connections

Specifications subject to change without notice.

Wiring Termination



BAPI recommends wiring the product with power disconnected. Proper supply voltage, polarity and wiring connections are important to a successful installation. Not observing these recommendations may damage the product and void the warranty.

Table 1: EZ Pressure Sensor Termination

Output Signal	Power Terminal	Gnd/4-20mA Terminal	Voltage Output Terminal
4 to 20 mA	7 to 40 VDC	4 to 20 mA Signal To Controller Analog Input	Not Used
0 to 5 VDC	7 to 40 VDC or 18 to 28 VAC	To Controller Ground	0 to 5 VDC Signal To Controller Analog Input
0 to 10 VDC	13 to 40 VDC or 18 to 28 VAC	To Controller Ground	0 to 10 VDC Signal To Controller Analog Input

4 to 20 mA, “Two Wire” Operation

- Connect the EZ Pressure’s [Power] terminal to a DC voltage of 7 to 40 VDC.
- Connect the [Gnd/4-20 mA Out] terminal to a 4-20mA input on your controller.
- The [Voltage Out] terminal is not used for 4 to 20 mA signaling.

0 to 5 V or 0 to 10 V, “Three Wire” Operation

- Connect the EZ Pressure’s [Power] terminal to:
 - 7 to 40 VDC or 18 to 28 VAC (for 0 to 5 VDC output units)
 - 13 to 40 VDC or 18 to 28 VAC (for 0 to 10 VDC output units).
- Connect the terminal labeled [Gnd/4-20 mA Out] to the controller’s ground.
- Connect the [Voltage Out] terminal to an analog input configured for voltage input.

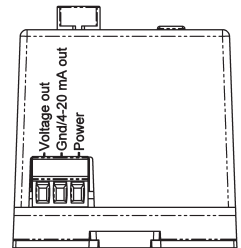

Fig. 7: Wiring terminations

Note: The terminals use a rising block screw terminal to hold the wires. It is possible for the block to be in a partially up position allowing the wire to be inserted under the block. Be sure that the connector screws are turned fully counterclockwise before inserting the wire. Lightly tug on each wire after tightening to verify proper termination.

Front Panel Operation

The rotary switch is used to select the pressure range, bi-directional or uni-directional pressure range, output range or to auto zero the unit. The notch in the knob indicates the switch position. The rotary switch in Fig. 8 is indicating 0 (zero), showing that the switch is in the Auto Zero position.

Pressing the NEXT button toggles between values when the rotary switch is in the [+/-] bi-directional or uni-directional pressure or [OUT] output range position. The NEXT button is also used to initiate [0] Auto Zero or change the display mode.

AUTO ZERO SELECT (Table 2)

- Connect the high and low ports together with a short length of tubing without kinks.
- Place the rotary switch into the [0] position. The display will show Aut0.
- Press the NEXT button. The display will show a series of progress bars starting with one bar and ending with four.
- When the Auto Zero is complete, the display will show “done” for about 4 seconds, then Aut0.
- Return the rotary switch to the desired pressure range (see Pressure Range Select).

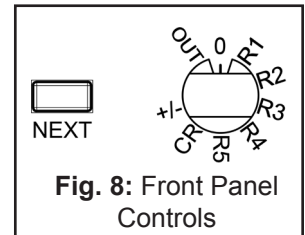

Fig. 8: Front Panel Controls

Table 2: Auto Zero Display Sequence

Rotary Switch Position	Initial Display	After Pushing NEXT button	When Complete
	Aut0		done

Table 3: Output Range Select Display Sequence

Rotary Switch Position	4 to 20 mA output	0 to 5 VDC Output	0 to 10 VDC Output
	4-20	0-5	0-10

OUTPUT RANGE SELECT (Table 3)

- Place the rotary switch into the [OUT] position.
- Press the NEXT button until the desired output range is showing on the display.
- Return the rotary switch to the desired pressure range (see Pressure Range Select).

Specifications subject to change without notice.

Front Panel Operation continued....

PRESSURE RANGE SELECT

Rotate the rotary switch to any of the positions labeled [R1] through [R5] or [CR] for a Custom Range. (Note: Custom Range units will have the pressure range printed on the label.) The display will show the pressure range for 2 to 4 seconds, and then the display shows the differential pressure across the ports. Inches of Water Column (WC) or Pascal units are selected at the time of order.

UNI-DIRECTIONAL OR BI-DIRECTIONAL RANGE SELECT

All pressure ranges can be made uni-directional or bi-directional.

- Place the rotary switch into the [+/-] position. The directional mode will show on the display.
- Press the NEXT button until the desired mode shows on the display.
- Return the rotary switch to the desired pressure range.

Rotary Switch Position	Uni-Directional Pressure	Bi-Directional Pressure
	Un	-b

Rotary Switch Position	Inches W.C.	Pascals
	0.1 in	30 Pa
	0.25 in	50 Pa
	0.5 in	100 Pa
	0.75 in	175 Pa
	1.0 in	250 Pa

ACTIVE OR INACTIVE DISPLAY MODE SELECT

The EZ Pressure Sensor can be in “active” or “inactive” display mode. In “active” display mode, the four-digit display shows the differential pressure from -1.0” to 1.0” WC or -250 to +250 Pascals, depending on model. In “inactive” display mode, the four-digit display simply shows On.

To switch display modes, follow the procedure below.

- Place the rotary switch into the blank position, see Fig. 9.
- If the unit is in the “active” mode, the display will show either the In (inches of WC) or Pa (Pascals) icon. If it is in the “inactive” mode, the display will read “On”.
- Press and hold the NEXT button (approximately 7 seconds) to toggle to the desired mode.
- Return the rotary switch to the pressure range required

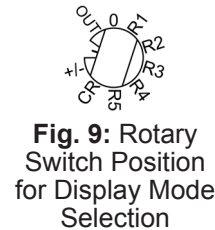

Fig. 9: Rotary Switch Position for Display Mode Selection



Fig. 10: Display message during “Inactive” Display Mode

Typical Applications

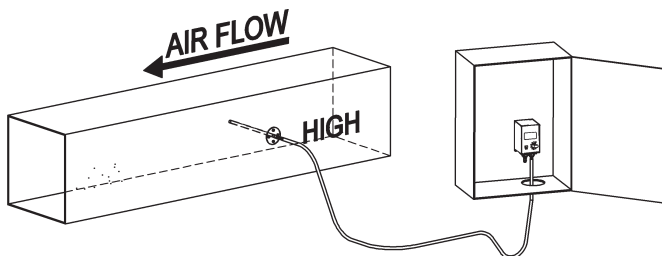

Fig. 11: Duct static pressure monitoring with the BAPI EZ Low Pressure Sensor mounted in a panel with a static probe (ZPS-ACC07) in the duct.

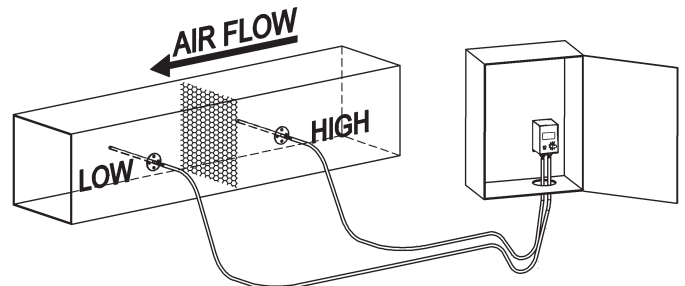

Fig. 12: Air filter pressure drop monitoring with the EZ Low Pressure Sensor mounted in a panel with two static pressure probes (ZPS-ACC07) in the duct.

NOTE: Best practice is to form a drip loop in the tubing to prevent condensation from reaching the sensor.

Specifications subject to change without notice.



EZ Pressure Sensor, Low Pressure Ranges

Installation and Operation Instructions

26910_ins_EZ_low_press.indd

rev. 06/22/2017

Troubleshooting

POSSIBLE PROBLEMS:

Display does not light

Output stuck either high or low or not tracking pressure properly.

POSSIBLE SOLUTIONS:

- Check power connections for proper power (see specifications below).

- Remove pressure from ports and perform Auto Zero procedure described on page 2.

Specifications

Power:

7 to 40 VDC (4 to 20 mA Output)
7 to 40 VDC or 18 to 28 VAC (0 to 5 VDC Output)
13 to 40 VDC or 18 to 28 VAC (0 to 10 VDC Output)

Power Consumption:

20 mA max, DC only at 4 to 20 mA Output
4.9 mA max DC at 0 to 5 VDC or 0 to 10 VDC Output
0.12 VA max AC at 0 to 5 VDC or 0 to 10 VDC Output

Load Resistance:

4 to 20 mA Output 850 Ω Maximum @ 24 VDC
0 to 5 VDC or 0 to 10 VDC output 1KΩ minimum

Accuracy at 72°F:

±0.5% of range 0 to 0.1", 0 to 0.25", ±0.1" and ±0.25" ranges
±0.5% of range 0 to 30 Pa, 0 to 50 Pa, ±30 Pa and ±50 Pa ranges
±0.25% of range all other ranges

Stability: ±0.25% F.S. per year

Temperature Error:

0.04% FS/°F (0.07% FS/°C)
(±1.0" W.C. @ 14 to 140°F [-10 to 60°C])

Environmental Operation Range:

14 to 140°F (-10 to 60°C)

Storage Temperature: -40 to 203°F (-40 to 95°C)

Overpressure: Proof: 27.68 in W.C (1 PSI),
Burst: 41.52 in W.C. (1.5 PSI)

Wiring: 3-wire removable terminal block (14 to 24 AWG)
2 wires (4 to 20mA Current loop)*
3 wires (AC or DC powered, Voltage out)

Humidity: 0 to 95% RH, non-condensing

Port Connection:

1 High Pressure & 1 Low Pressure for push-on
1/4" tubing (1/8" to 3/16" I.D.)

Enclosure Material: ABS Plastic, UL94, V-0

Mounting:

DIN Rail, Snaptrack or Surface Mountable

Table 6: Low Pressure Ranges

Inches of Water Column (WC) Ranges				Pascal Ranges			
Range	Pressure	Range	Pressure	Range	Pressure	Range	Pressure
51	0 to 0.10"	56	± 0.10"	61	0 to 30 Pa	66	± 30 Pa
52	0 to 0.25"	57	± 0.25"	62	0 to 50 Pa	67	± 50 Pa
53	0 to 0.50"	58	± 0.50"	63	0 to 100 Pa	68	± 100 Pa
54	0 to 0.75"	59	± 0.75"	64	0 to 175 Pa	69	± 175 Pa
55	0 to 1.00"	60	± 1.00"	65	0 to 250 Pa	70	± 250 Pa

Specifications subject to change without notice.